

T VIEW

D75TSB

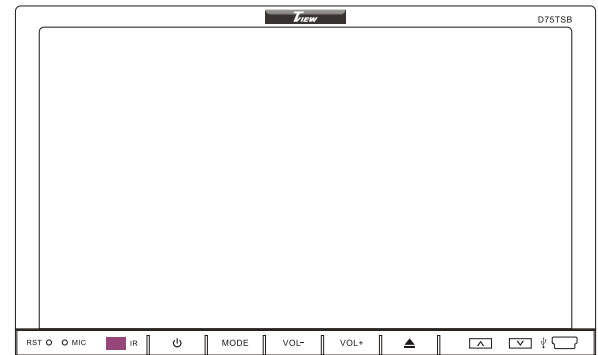











Printing Color: White/Black.
Material QUALITY: 100g wood-free printed paper.
Size: A6

OWNER'S MANUAL

Table of contents

Safety Precautions.....	1
Main Features.....	2
User Introduction.....	3
Wiring Diagram.....	3
Unit Rear Side Connection.....	4
Appearance and Function Introduction.....	5
Connect To Storage Accessories.....	5
Remote Control Operation.....	6
Touch Screen Menu And Operation.....	9
Bluetooth system settings.....	9
DVD Mode Menu Interface.....	10
USB/SD Operation.....	11
Radio Function Interface.....	11
Audio/Video Menu Setup.....	12
SYS System Settings.....	13
DVD System Settings.....	14
Function Index Sign.....	15
Warning.....	16
Trouble Shooting.....	16

Safety Precautions

-  This product without waterproof function. To avoid the risk of fire breakout or electric shock, please do not expose this unit in the rain or moist environment. Do not open the cabinet. Such operation will absolve relative maintenance guarantee. Only the legally authorized professionals are allowed to conduct such operation.
-  **LASER:** This unit installs a laser system. To ensure proper use of this product, please read this owner's manual carefully before operating this unit and keep it for future reference. If the unit requires maintenance, please contact an authorized professional. Please operate according to correct process in order not to hurt by laser beam.
-  Please use this unit at normal temperature. Do not put the unit under -10 degree or higher than +60 degree environment. Otherwise it will distort the plastic shell, debase the display quality and products quality.
-  Installation should be very tight and secured to prevent the fallen unit hurt people and damage the unit when moving on or a sudden brake.
-  Please install carefully to avoid damaging working platform. Please clean the internal working platform, and ensure sufficient space for installation. Inner shell will be installed on the working platform. Then install the mainframe, connecting the power and video signals jack, then put mainframe into the shell. Then assemble the shell with the mainframe device.
-  Please do not try to repair display device by yourself. It is made up of many precision electronic elements, and any dismantlement or refit will make it damaged or broken. If any problem on the unit, please switch off the power immediately, and consult your nearest seller or distributor.
-  Please keep the monitor away from the pollution of moisture, dust, water soot etc. Please switch off the power immediately if any moisture or other objects pollute, please contact the seller or distributor.
-  If you drive with the sound at a level preventing you from hearing sounds outside the car please keep the unit at an appropriate sound level, otherwise this may affect your driving and cause an accident.
-  For your safety, please do not watch or operate the monitor when you are driving.
-  The apparatus shall not be exposed to dripping or splashing and that no objects filled with liquids, such as vases, shall be placed on the apparatus.

Preface

Thank you for your support of the company's products and options. This unit is crystallization of the modern high-tech. It is a cross-functional player mode and adjustable true color LCD automatic retractable screen LCD touch screen. Allows you to be arbitrary choice To appreciate the program. Here, we wish you to personally experience this high-tech products can be Perfect fun and enjoyment. To ensure proper use of this product, please read this owner's manual carefully before operating this unit and keep it for future reference.

Note: The graphics of this manual are for your reference only, please in-kind products prevail.

Main Features

1. 7" Wide screen TFT LCD high-definition media player monitor.
2. This unit is with touch icon interface and touch button icon.
3. Built-in AV / DVD / USB / SD / FM/AM /Bluetooth function.
4. DVD/VCD/MP3/CD/MPEG compatible.
5. FM/AM digital synthesizer tuner with 30 memory presets.
6. Intelligentize bluetooth function, for you to make and answer the phone comfortably.
7. Built-in 4X25W power amplifier, 4.1 soundtrack audio output, can connect to external audio device.
8. Signal: 1 video output, 1 video input.
9. Under car reverse mode, can auto switch to the reversing mode, if connect to the camera, can observe the back side of car to ensure the safety.
10. Menu function: all function is operated by OSD menu.
11. Display system: AUTO/PAL/NTSC.
12. Auto memory: all the feature or position adjustment can be auto memoried and will auto resume.
13. Support USB/SD card to play MP3/MP4/WMA/AVI/JPEG media format.
14. Remote control: full function remote control operation.
15. Picture pixel:800*480
16. Power: DC 12V $\pm 10\%$; Low power consumption: $\sim 25W$.
17. Working Temp: $-10^{\circ}C \sim 60^{\circ}C$.
18. Max Current: 10 A.
19. This unit has anti shock function.

User Introduction

1. Please connect the signal cable with power cable according to "Unit rear side connection" to connect to power and signal.
2. After connect to power, press the power button, screen to enter the main interface.
3. When display DVD or VCD disc, the unit is automatically identify the video system PAL and NTSC.
4. Can through the button on panel to adjust the function. And can use the remote control or touch screen to adjust the function.

Wiring Diagram

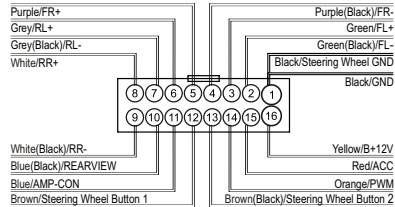

1. Black/Steering Wheel GND, Black/GND: connect to ground.
2. Green/Black/FL-: Front left audio output (cathode).
3. Green/FL+: Front left audio output (positive pole).
4. Purple/Black/FR-: Front right audio output (cathode).
5. Purple/FR+: Front right audio output (positive pole).
6. Grey/RL+: Rear left audio output (positive pole).
7. Grey/Black/RL-: Rear left audio output (cathode).
8. White/RR+: Rear right audio output (positive pole).
9. White/Black/RR-: Rear right audio output (cathode).
10. Blue/Black/REARVIEW: Car reversing cable.
11. Blue/AMP-CON: Control power amplifier switch.
- 12/13. Brown/Steering wheel button 1, Brown/Black/Steering wheel button 2: Connected to the steering wheel button (positive pole).
14. Orange/PWM: Headlight control
15. Red/ACC: Trigger power
16. Yellow/B+12V: +12V power cable.

Unit Rear Side Connection

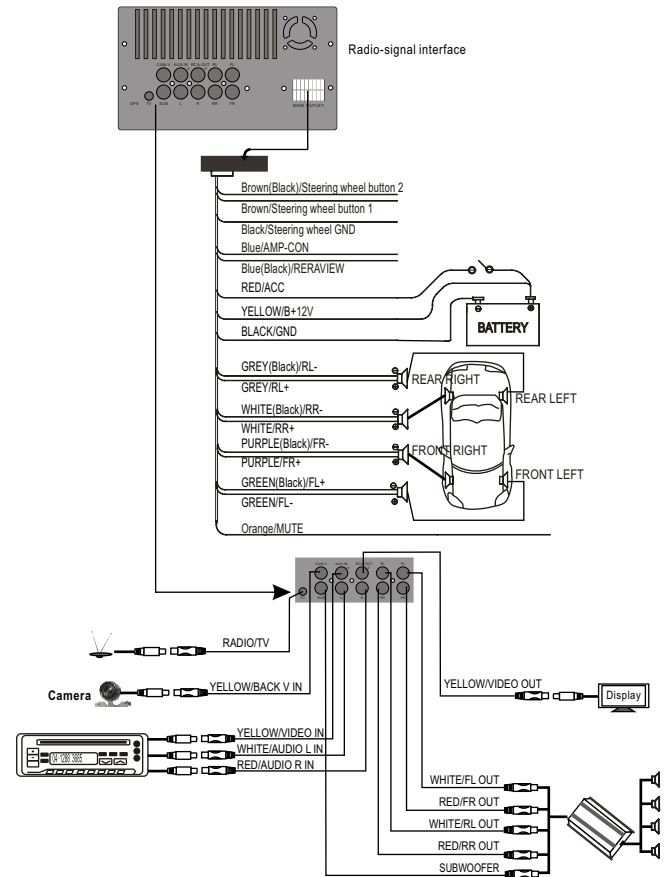

Appearance and Function Introduction

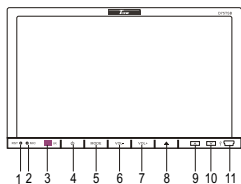

1. RESET: Reset button.
2. MIC: Microphone.
3. Remote control window.
4. Power on/off button
5. MODE: Display mode switch.
6. VOL-: Control for the volume reduce, and can use for MENU adjustment.

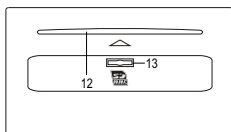

7. VOL+: Control for the volume increase, and can use for MENU adjustment.
8. Disc eject
9. Display panel slip out.
10. Display panel retract.
11. Mini USB connector.
12. Disc slot.
13. SD card reader.

Connect To Storage Accessories

Connecting With USB

1. Under power on mode, click the USB icon in the main interface, it will play the USB.
2. It will display "USB READ ", then play the file.
3. Pull out the USB when you want to stop playing.
If there are some file in the memory card that can't play, please delete it then connect to the unit to read the file.

Connecting With SD Card

1. Under power on mode, click the SD icon in the main interface, it will play the SD card.
2. Will show can play the file.
3. Pull out the SD card when you want to stop playing.
Note: Please take attention for the SD card using direction, upward label side , then insert the card.

Remote Control Operation

1. : Power
Press this button to turn on/off the unit.
2. : Play/Pause
3. : MUTE
4. Cursor direction key
Press these to move cursor.
5. System Select: BND/TA/SYS
6. Enter
7. Volume: VOL+/VOL-
8. SEEK- /SEEK+ : Previous/next
9. DVD Programming
10. OSD
Press it to display the disc information.
11. SEL: Sound adjustment function
12. AMS/RPT

13. Under DVD mode, press it for shuffle
14. Number: Pilih lagu
15. AUDIO memilih mode.
16. Switching sub menu
17. Subtitle on/off
18. Anycast title, chapter, audio, subtitle
19. MODE: Change modes
20. : Stop playing
21. DVD display disc there are more angle select (need the disc support)
22. SLOW: slow forward/slow playing
23. SETUP: DVD system setup
24. TITLE

Return to the menu title

Precautions Before Using Remote Control Unit

1. Please pull out the PVC when the remote control unit is first using.
2. Don't drop or step in remote control unit or subject it to shocks.
3. Note that it maybe impossible to operate the main unit if there are obstacles between it and the remote sensor.
4. Using the remote control unit within the specified operating range.

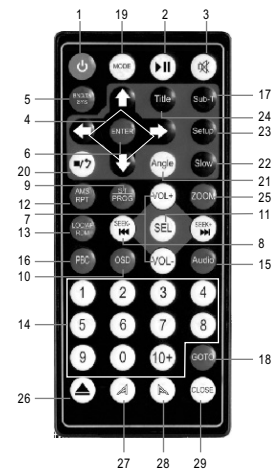

25. ZOOM
Press it can zoom or shrink picture displayed
26. : Eject button.
press this button to eject or slot-in the disc
27. : Display panel slip out.
28. : Display panel retract.
29. CLOSE: press it, the monitor will auto-extend or return.

Remote Control Unit Operating Range

Horizontal: ±30 degree

Vertical: ±30 degree

Distance: 6M

Replacing The Battery

1. Insert your finger nails into A and B on the diagram below, press A according to the direction, then pull out the battery holder.

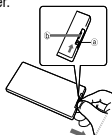

3. Fit the battery holder back to its place.

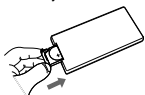

2. Remove the old battery, then insert the new battery into the battery holder with the + side facing upwards.

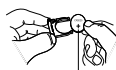

Lithium battery(Cr2025)

Note:

To prevent leakage of fluid from the lithium battery, remove the battery when not using the remote control unit for long periods of time(one month or more), If the battery leaks fluid, carefully wipe it out of the battery case, then change to a new lithium battery.

Basic Operation

1. Power on /off
Press the "⏻" button on remote control, enter into power on condition, press this button again to turn off the unit.
2. PLAY/PAUSE
On normal play disc mode, press this "⏮" button to pause. Press this button again to continue playing.
3. ⏹ STOP
In play mode, press it to stop playing, press "PLAY" button to resume playing.
4. INPLAY /OUT
Press to eject the disc. The disc into the disc slot, will inhale automatically.
5. Adjust panel angle
Press "⤴" "⤵" button on remote control, can adjust the panel angle.
6. MUTE control
Press "⊘" button on remote control to turn off the sound. Press it again will resume the previous volume level.
Note: there are some functions no work when mute.
7. Function mode switch
Press "MODE" button on remote control to switch the mode. But if the unit without disc/SD/USB inside, can't enter to DVD/SD/USB mode.
8. "⏮" "⏭"
In DVD mode, short-press for previous/next item, long-press for fast forward/fast back;
In FM mode, short-press for adjust radio frequency, long-press for manual search forward/up/down; In TV mode, short-press for previous / next channel, long-press for fine-tuned.

9. ODD:

Press the OSD remote control key, the screen will display elapsed time, remaining time, title, chapter, time, section time, time remaining chapters, show off

10. Select the subtitle
11. Press "Sub-T" to select different subtitles inherent in DVD disc.
12. Press ZOOM key for times, the picture will change in order of 1/2, 1/4, 1/8, and 1/16 of normal size. (Note: When playing MP3/USB/SD, this button is invalid.)
13. Press SLOW on the remote control to slow playing. Change the playing speed to 1/2, 1/4, 1/8, and 1/16 through pressing SLOW button.
14. During playback press the "AUDIO" voice key, can be included on the DVD disc in a variety of audio languages to choose.
15. "GOTO" chooses play button, Press it, the play information will show on screen, use cursor button on the remote control to choose disc title, chapter or time and then press "enter" button to play.
16. Press ANGLE to select the play angle when the main unit is in play mode for DVD disc, there is no function for other disc. It will be no working if the disc not have this function.
17. Press ZOOM key for times, the picture will change in order of 2X, 3X and 4X of normal size. (Note: When playing MP3/USB/SD, this button is invalid.)
18. The main unit may auto play the list according to the order of title, chapter or set list; Press ST/PROG, the menu will shown on the screen.

Hint: TT is for Title, CH is for Chapter of DVD disc, DVD disc is divided into several parts called Title. Then title is divided into chapter; Normally one movie only corresponding to one title. CD disc is divided into several items. For KARAOKE disc one music corresponding to one title.

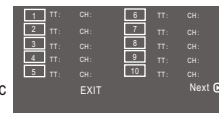

Use the ⬅️ ⬆️ ⬇️ ⬇️ ➡️ and number button, to input the corresponding title, chapter, same as the picture showing:

Use ⬅️ ⬆️ ⬇️ ⬇️ ➡️ move cursors to "play", press "enter" button, the unit starts playing on the program list. Press "Play/Pause" button or choose "Exit" button, press "enter" to exit.

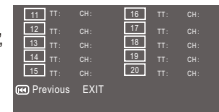

NOTE:

- (1). The program list will be cancel when the main unit is power off or eject the disc.
- (2). There is no program function for some disc.
- (3). The unit can not play the list if you select the item that does not exist in the disc.

Touch Screen Menu And Operation

Main Interface

Once opening the unit, it can automatically enter into the main interface, As shown

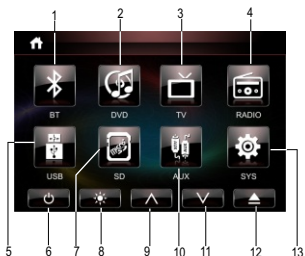

1. BTPHONE: Bluetooth function.
2. DVD mode
3. TV function mode. (Invalid Function keys)
4. RADIO: radio mode
- 5/7. USB/SD: Memory signal input mode, (Connect the usb/sd can be to enter)
6. POWER: Off key
8. Close the screen display, and then click on the screen nback to normal.
- 9/11. ∨ / ^ Adjust panel angle upward/down
10. AUX: AUX signal input mode.
12. ▲ : press this button can slip in/out disc
13. SETUP: setup menu.

Touch screen "1,2,4,5,7,10,13" the center of the corresponding function, the screen immediately enter to interface of your chosen functions mode. If have connected signal source, there are clear picture for you to enjoy. Touch the screen "6" off; touch "13" point can enter the setup menu to set product function and display; specific instructions, please refer to the corresponding menu interface. Touch screen "9,11" points to adjust the panel angle up or down to meet your visual requirements.

Touch corresponding center icon on the screen, then can enter into the interface what function you choose

Bluetooth system settings

Press the remote control "mode", select display picture, or icon on the touch screen to enter the BT Bluetooth mode: see the picture below.

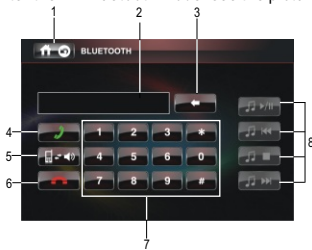

1. Back to the main interface.
2. Status Information shows column.

3. Delete button: touch the button can delete the already input number.
4. Dialing button: answer and make the phone.
5. Press the call state, phone call mode conversion mode with the external call
6. Hang up button: end the call or refuse the call.
7. Number buttons
8. When play songs by bluetooth, they act as respectively pause/play, previous song, stop playing and next song

Operating instructions

1. Starting up and enter into the bluetooth system picture.
2. Open up the bluetooth equipment of the mobile phone can search this unit's bluetooth equipment "CAR KIT".Then match the bluetooth by presentation.
3. Input 4 figures pass code"0000",this unit's bluetooth will be set up to the authorized equipment of the mobile phone. If the match is successful the status of the bluetooth picture will show "LINK OK"

Tips: If it unable to match please starting up again. After setting up the unit to authorized equipment, the bluetooth will connect or enter into mobile phone bluetooth system automatically. Select "CAT KIT"to connect it.

4. After you match successfully you can make and answer the phone comfortably. Within the effective limits, this unit can also transmit the music which is playing in the mobile phone. And can adjust the voice through mobile phone. (Within the effective limits of 10 meters).

Cautions: This unit can only match with one mobile phone equipment which has bluetooth function. The bluetooth function of this unit can only receive audio frequency information.

DVD Mode Menu Interface

Panel or by remote control "MODE" ; Or on main menu to touch MEDIA icon enter to DVD mode(touch screen the menu toolbar appears when the menu toolbar Hide):

1. Back to the main interface
- 2/3.VOL-/VOL+ :Volume control button
- 4/6.◀◀/▶▶: previous /Next
- 5/7.▶▶/◀◀: Fast forward / Fast back
- 8.■ : Stop
- 9.▶▶: Play/Pause
- 10.MUTE
- 11.AUDIO: In DVD playback, press this button, Press it to select the channel when the main unit is in play mode for DVD disc
- 12.RPT
- 13.TITLE
- 14.MENU
- 15.SUB:Subtitle selection(need the disc support)
- 16.SET:Tools, Touch it enter to AUDIO/VIDEO menu(Please refer to audio / video menu description)
- 17.▲:Disc out of the warehouse

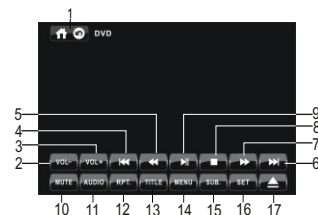

Note :

In any mode, once placed the DVD disc, it will automatically switch back to DVD mode.

USB/SD Operation

When the unit connect USB/SD, touch the "USB" or "SD" icon in main interface, will auto read .As shown:

- 1.Close the screen display, and then click on the screenback to normal.
- 2/3.Volume control button
- 4.PRT
- 5/6.◀▶ Previous/Next
7. ▶⏸ Play/Pause
8. ■ Stop

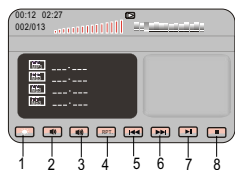

When playing USB or SD card, Touch the DVD menu arrow keys to move the cursor to the file bag, file, MP3 or JPEG icon you want, and then press to confirm the selection, the selected file will automatically play . Play JPEG photo files, touch to confirm the current picture to exit picture playback, press the stop button to exit.

While the USB/SD is playing, and if you Insert the disc, will go to DVD playing. Pull out the USB/SD when you want to stop playing. Click the file directly can play the selected file. Note: Click the bottom half of the screen can appear "Actions" menu, then click the " disappeared.

Radio Function Interface

After opening the machine, Select main screen or select on the remote control "mode" to switch to the RADIO,As shown:



- 9/10.Receiving frequency tuning
11. Status Information shows column.
- 12.FM/AM band shows

- 1.Close the screen display, and then click on the screenback to normal.
2. MUTE:Touch MUTE to turn off the sound, press again to resume to previous volume level.
- 3/4. Volume adjustment buttons
5. SCAN: Touch "Scan" Department, will automatically search for and select "SGAN" will automatically save
6. BAND: Select FM/AM wave band.◦
- 7/8.Click the Search radio channel up / down

Audio/Video Menu Setup

Under DVD mode, touch "SET" button enter to "AUDIO/VIDEO"menu setting interface.
(Picture 1) Audio setting interface

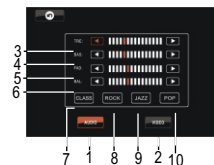

1. AUDIO mode: Touch this icon, the icon is concave, then will enter to audio setting mode.
2. VIDEO mode: Touch this icon, the icon is concave, then will enter to video setting mode.
- 3.TRE: Alt volume adjustment, Touch the "▶◀" icon, on the screen, the alt volume will change.
4. BAS: BAS: Bourdon volume adjust. Touch the "▶◀" icon on the screen, the bourdon volume will change.
5. FAD: Front and Rear volume adjustment, Touch the "▶◀" icon on the screen, the Front and Rear volume will change.
- 6.BAL: Left and right track adjustment, Touch the "▶◀" icon on the screen, the left right track volume will change.
- 7.CLASS
- 8.ROCK

(Picture 2) Video setting interface

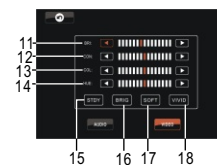

9. JAZZ
- 10.POP
11. BRI: Brightness
Touch the "▶◀" icon on the screen, to adjust the picture brightness.
- 12.CON: Contrast,
Touch the "▶◀" icon on the screen, to adjust the picture contrast.
- 13.COL: Color,
Touch the "▶◀" icon on the screen, to adjust the picture color.
- 14.HUE: Hue,
Touch the "▶◀" icon on the screen, to adjust the picture hue.
15. STDY: Standard mode.
16. BRIG: Brightness.
17. SOFT: Soft.
- 18.VIVID

SYS System Settings

After opening the machine, Under the main menu screen on the touch screen "SYS" key to enter "SYS" system setting interface,Interface shows AUDIO/VIDEO、Steering、 Touch prospective effect、 Language settings, As shown; prompt:Set the audio / video and DVD menu when audio/video mode operation the same Steering operate

When the user want to re-set steering wheel keys for short-cut purpose, firstly, press the "Delete" key to delete the previously set before re-designate functions on steering wheel, Secondly, long-press he buttons of the car's steering wheel and hold down the "function "keys on car, and then click "learn" button on the steering wheel of the unit. Thirdly, select the appropriate function you like, the status bar on the unit will display the corresponding information, Fourthly, click the "save "button on the screen of the unit.When exist, you can achieve the purpose for setting the steering wheel functions.

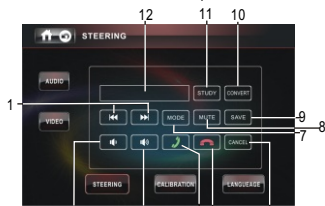

1. Previous song/Next song
- 2/3. Volume adjustment buttons
4. Dialing button: answer and make the phone.
5. Hang up button: end the call or refuse the call.
6. CANCEL
7. MODE
8. MUTE
9. SAVE
10. STUDY
11. POWER
12. Status Information shows column.

Note:All keys in the steering wheel are invalid if not in the learning setting mode.

Touch-efficiency adjustment

Touch-efficiency adjustment (follow the prompts to click on the center of "+" sign, if successfully adjust, it will auto-exit)

Language settings

1. Back to the main interface
2. English / Portuguese

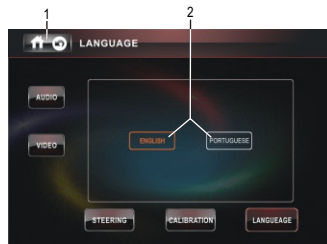

DVD System Settings

Under the DVD display mode, press the "SETUP"button on remote control, Press "↑ ↓ ← →" to move the cursor and "ENTER"Confirmation option Conduct General Setup Page、 Audio Setup Psage、 Video Setup Page and Preference Page, below is for the details menu for your reference

1. General Setup Page

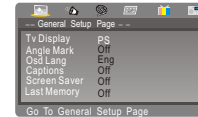

General Setup Page	
Tv Display Wide	4:3 Paniscan
Angle Mark	Off 4:3 Letterbox
Osd Lang	Eng 16:9
Captions	Off
Screen Saver	Off
Last Memory	Off

General Setup Page	
Tv Display Wide	Off
Angle Mark	Off On
Osd Lang	Eng Off
Captions	Off
Screen Saver	Off
Last Memory	Off

General Setup Page	
Tv Display Wide	English
Angle Mark	Off Chinese
Osd Lang	Eng French
Captions	Off German
Screen Saver	Off Italian
Last Memory	Off Portuguese
	Spanish

General Setup Page	
Tv Display Wide	
Angle Mark	Off
Osd Lang	Eng
Captions	Off On
Screen Saver	Off Off
Last Memory	Off

General Setup Page	
Tv Display Wide	
Angle Mark	Off
Osd Lang	Eng
Captions	Off
Screen Saver	Off On
Last Memory	Off Off

General Setup Page	
Tv Display Wide	
Angle Mark	Off
Osd Lang	Eng
Captions	Off
Screen Saver	Off
Last Memory	Off On
	Off

2.Audio Setup Psage

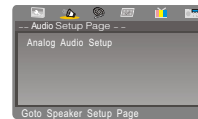

In the Audio setup menu,it has submenu choice-"It/Rt""Stereo"two submenu choices.

3. Video Setup Psage

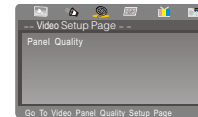

In the video settings menu, The quality of the LCD screen to set a plan "Sharpness" "Brightness" "Contrast" "Hue" "Saturation" Sub-menu to choose from, Press the remote control arrow keys on the LCD screen can be set to adjust picture quality

4. Preference Page

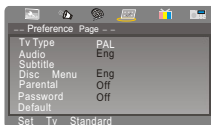

Preference Page		
Tv Type	PAL	PAL
Audio	Eng	ATUO
Subtitle		NTSC
Disc Menu	Eng	
Parental		
Password		
Default		
Set Tv Standard		

Preference Page		
Tv Type	PAL	English
Audio	Eng	French
Subtitle		Spanish
Disc Menu	Eng	Chinese
Parental		Japanese
Password		Korean
Default		Russian
Preferred Audio Language		

Preference Page		
Tv Type	PAL	English
Audio	Eng	French
Subtitle		Spanish
Disc Menu	Eng	Chinese
Parental		Japanese
Password		Korean
Default		Russian
Set Preference To English		

Preference Page		
Tv Type	PAL	English
Audio	Eng	French
Subtitle		Spanish
Disc Menu	Eng	Chinese
Parental		Japanese
Password		Korean
Default		Russian
Preferred Menu Language		

Preference Page		
Tv Type	PAL	1 Kid Safe
Audio	Eng	2 G
Subtitle		3 Pg
Disc Menu	Eng	4 Pg 13
Parental		5 Pgr
Password		6 R
Default		7 Nc 17
Preferred Menu Language		

Function Index Sign

FM	FM Frequency range	87.5~108.0MHZ
	Noise limit sensitivity	15dBu
	S/N Ratio	50dBu
	Antenna resistance	75 Ω
TV	VHF-L	49.25~85.25MHZ
	VHF-H	168.25~216.25MHZ
	UHF	417.25~863.25MHZ
	TV Type	PAL B/G, I/I, D/K NTSC
	Antenna resistance	75 Ω
AUDIO	S/N Ratio	80dBu
	Max output power	25W*4CH
VIDEO	Video output scope	1+/-0.2V
	Video Horizontal Resolution	≥600

Warning

- To ensure the accurate of touch function, please touch the center point of relative function.
- There are build in anti-jamming system in touch screen, to prevent the wrong position touch, please keep to touch this function for 0.5 second, then the product will get respond for your instruction.
- Please do not use the object, which is bigger than the function icon to touch the screen. Otherwise the touch function will failure or give the wrong operation to other function.
- To ensure the panel safety, please don't press or use the sharp object to touch the panel.
- Don't play the severity scratch disc, otherwise will damage the DVD play capability.
- Be sure to distinguish the anode and the cathode when connecting the power. If connect wrong, the fuse in filter box will melt immediately to protect unit. Then please replace the same parameter fuse.
- DC 12V should be best to connect with the power adapter to prevent from the over-voltage drop the may influence the normal work of the monitor.
- Keep this machine away from too hot, or under effect of moisture, dust or oil smoke, avoid this machine from dropping or impacting, never extrude or chafe this machine with sharp objects.
- Dangerous high voltages are present inside the enclosure. Do not open the cabinet, non-professionals can not disassemble unit.
- Installation should be very tight and secure. Preventing the fallen unit hurt people when moving on or a sudden brake.

Trouble Shooting

PROBLEM	CAUSE	SOLUTION
Cannot power on	Check whether power fuse melt or not	Change fuse same as the old one.
	Some factor cause MCU wrong operation	Press RES button on the panel by penpoint, then power on
After ignition switch off, setting information all lose	Wrong connection between ignition line ACC and power line anode pole	Reconnect line
Remote control no function	No enough power supply from battery	Change battery of remote control
Poor performance of radio station	Improper set of length of antenna, poor connection of antenna grounding	Check whether antenna is connected or not, or poor connection.
Cannot play disk	Disk is scratched.	Change new disk
	Put wrong side of disk into unit.	Slot in the disk with sign side up
Disk has dirty.		Clean disk
Cannot switch language/subtitle	There is only one language/subtitle in dish	If disk is not with multi-language/subtitle, it cannot switch language/subtitle
No image	Video line between unit and TV is not properly connected.	Reconnect lines